

It all hinges on excellence.

SIMONSWERK



TECTUS®

The completely concealed
hinge system

Content

TECTUS® – the completely concealed hinge system

Model versions from 60 to 300 kg			
14	TE 240 3D	60 kg	for unrebated and rebated flush residential doors
15	TE 340 3D	80 kg	for unrebated residential and heavy-duty doors
16	TE 526 3D	120 kg	made of solid stainless steel for unrebated heavy-duty doors
17	TE 527 3D	120 kg	made of solid steel for unrebated heavy-duty doors
18	TE 540 3D	120 kg	for unrebated heavy-duty doors
19	TE 640 3D	200 kg	for unrebated high performance heavy-duty doors
20	TE 645 3D	300 kg	for unrebated high performance heavy-duty doors

Model versions for special applications			
24	TECTUS® A8		for unrebated high performance heavy-duty doors with claddings up to 8 mm
26	TECTUS® Energy		with permanent energy transfer
28	TECTUS® FVZ		for unrebated residential and heavy-duty doors with recessed frame facings
30	TE 380 3D	60 kg	for rebated residential doors
32	TE 680 3D FD	160 kg	for rebated entrance doors
34	TECTUS® FR		with integrated intumescent kit

Fixing plates and receivers			
36	TE 640 3D BW		for unrebated heavy-duty doors with claddings up to 16 resp. 20mm on both sides
37	TE 626/640 3D A8 BW/1		for unrebated heavy-duty doors with claddings up to 20mm on both sides
38	TE ... 3D FZ		for residential and heavy-duty doors with casing frames
39	TE ... 3D SZ		receiver for residential and heavy-duty doors on steel frames
40	TE ... 3D ST		receiver for residential and heavy-duty steel doors

41	Assembly
----	-----------------

44	Finishes
----	-----------------

45	Service
----	---------

TECTUS® – the completely concealed hinge system

“Making something invisible is also design!” There is a certain appeal in designing items in such a way that their actual value is initially in the background, thereby giving space to other elements. Flush mounting is a stylistic principle that exudes minimalism and involves precise technology and perfection. The TECTUS series of concealed hinges offers unsurpassed quality, versatility and depth. The completely concealed hinge system TECTUS has been an integral part of the SIMONSWERK range since 2002. Thanks to its ongoing development, TECTUS is today more innovative and efficient than ever.

TECTUS® – the advantages at a glance

- completely concealed hinge system
- for flush-fitting architectural structures
- with load capacity of 60 to 300 kg
- comfortable 3D adjustment
- with an opening angle of 180°
- for unrebbated and rebatted flush doors
- for rebatted doors
- for timber, steel and aluminium frames
- with maintenance-free slide bearing technology



TECTUS – model versions from 60 to 300 kg

TECTUS hinges have impressive load-bearing capacities, being able to support door elements of up to 300 kg. They also have an opening angle of up to 180° and can be used with timber, steel and aluminium frames. The hinges can be adjusted in all three dimensions and require no maintenance. They are used on high-quality residential doors and functional heavy-duty doors in public buildings.

The wide range of finishes enables a variety of applications – they can be harmoniously tailored to an architectural concept and fittings and can completely blend into the background when the respective door is closed.





TECTUS® Energy – for permanent energy transfer

TECTUS Energy enables permanent energy transfer, without compromising on the design aspect of surface-flush appearances. It combines design, function and technology in an exemplary way and creates opportunities for new ideas. For fitting and operating electronic components in high-quality heavy-duty doors, the safe and permanent energy transfer is decisively important. TECTUS Energy secures the door leaf and permanently provides energy from the side of the frame without weakening the door or frame geometry. The technology provided together with TECTUS Energy offers compatibility with all standard versions of locks and fittings, while retaining all technical and optical features of the TECTUS product brand.

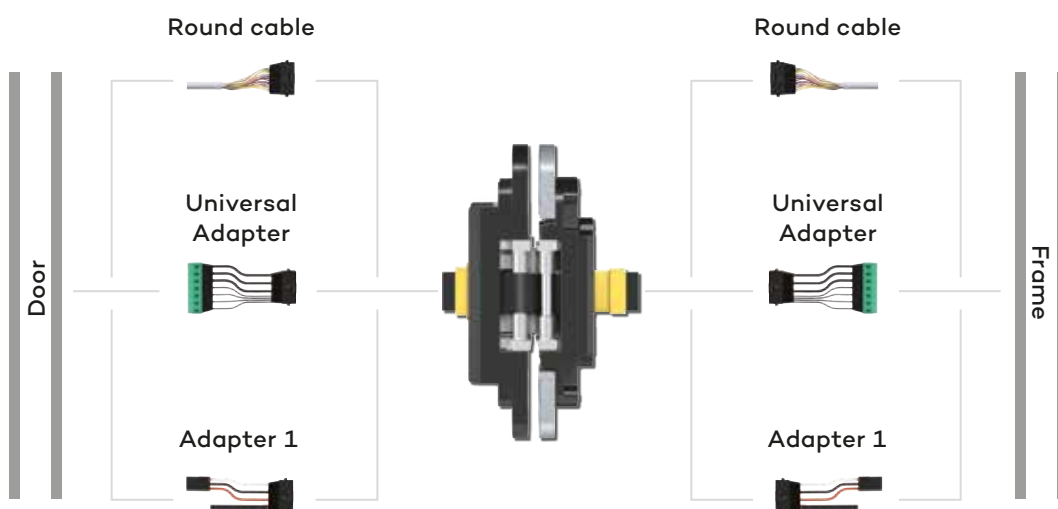

Großer Saal
2. Rang rechts

Rangfolge



Model versions for special applications

TECTUS A8 – for claddings up to 8 mm

The “A8” versions provide new application possibilities as they can accommodate claddings of up to 8 mm on the door and frame construction. This gives the designer more scope when integrating the door element into the overall interior design concept.

TECTUS FVZ – for doors with recessed frame facings

With TECTUS FVZ, a design where the frame part is offset to the sash part, it is possible to integrate a door with a completely concealed hinge into the surrounding wall without any visible frame. The frame facing can be set back by 12 or 14 mm, to allow the door and wall sets to create a flush-fitting whole.



Model versions for special applications

TECTUS rebate

for rebated residential doors

For rebated residential doors SIMONSWERK offers the TECTUS TE 380 3D. The concealed hinge system is completely invisible when the door is closed. The hinge joint's special geometry allows for installation in the rebated door leaf with a receiver in the wood, steel or aluminium frame.

for rebated timber entrance doors

With the product novelty TECTUS TE 680 3D FD SIMONSWERK has further developed the successful product brand TECTUS and offers with this new model version a solution for conventionally rebated timber entrance doors. Easy mounting and convenient 3D adjustment make installation easy, while a circumferential seal ensures the required level of impermeability around the hinges. The innovative hinge system for timber entrance doors further impresses with a load capacity of up to 160 kg. The TECTUS Energy version with permanent energy transfer is also available.

TECTUS FR – with integrated intumescent kit

The TECTUS FR model version is equipped with an integrated intumescent kit. Whilst maintaining all routing dimensions and optical features of the TECTUS, they provide the perfect basis for use on fire-resistant door elements. In case of a fire, the intumescent kit swells, sealing the door around the hinges, thereby protecting against fire and smoke escaping into a neighbouring room.



Design meets function

A full range of concealed hinges

For applications ranging from high-quality interior doors to heavy-duty doors with special requirements in terms of load capacity and performance, SIMONSWERK has for years provided a comprehensive product range including a wide choice of its completely concealed TECTUS brand.

All the models in the TECTUS brand completely concealed hinge range for high-quality interior and functional heavy-duty doors have the same technical and visual features, and can be used with timber, steel and aluminium frames. They all have a uniform appearance, with a closed hinge body that hides the milling from view, and are available in a range of materials and attractive surface finishes.



Versions for special applications from page 22.



TE 240 3D

load capacity
up to 60 kg



TE 340 3D

load capacity
up to 80 kg

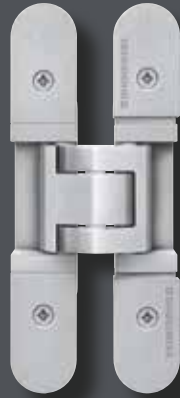

TE 526 3D

made of solid stainless steel
load capacity up to 120 kg

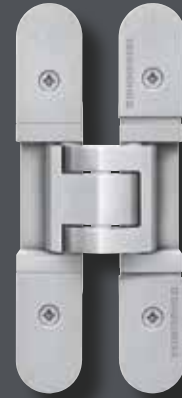

TE 527 3D

made of solid steel
load capacity up to 120 kg



TE 540 3D

load capacity
up to 120 kg



TE 640 3D

load capacity
up to 200 kg



TE 645 3D

load capacity
up to 300 kg

TECTUS®

TE 240 3D

for unrebated and rebated flush residential doors

hinge **up to 60 kg**

Product features

- completely concealed hinge system
- for timber, steel or aluminium frames
- for unrebated and rebated flush residential doors
- sideways closed hinge body for a homogeneous mortise appearance
- 3D adjustment (side +/- 3.0 mm, height +/- 3.0 mm, compression +/- 1.5 mm)
- maintenance-free slide bearings

Technical details

load capacity	i two hinges per door leaf (1x2m)	60.0 kg
overall length		155.0 mm
width (frame part)		21.0 mm
width (door part)		18.0 mm
cutter diameter		16.0 mm
opening angle		180°

Finishes

polished brassed (030), polished nickelled (038), satin brassed (047), RAL 9016 Traffic White (070), RAL 9005 Matte Black (107), Satin Chrome Look (F1) (124) Satin Nickel Look (F2) (125), Stainless Steel Look (SSL) (126), Satin Nickel (144) Satin Chrome (146), Rustic Umber (156), Bronze Metallic (168), Bronze Finish (174), Bronze Finish light (175), Bronze Finish dark (176), other finishes available upon request

Combination

receiver	casing frame	TE 240 3D FZ
	steel frame	TE 240 3D SZ
	steel door	TE 240 3D ST

Installation tools

jig		universal milling frame
frame	template	No. 5 250691 6
door	template	No. 5 250692 6

Note

i The load capacity mentioned above refers to the use of two hinges per door leaf (1x2 m).

With an opening position of 180° the door may have to be fixed additionally.

Classification key

2	7	2	0*1	1	—*2	0	7
----------	----------	----------	------------	----------	------------	----------	----------

*1 Test evidence for functional doors to be achieved with full door sets and assemblies.

*2 depending on the finish

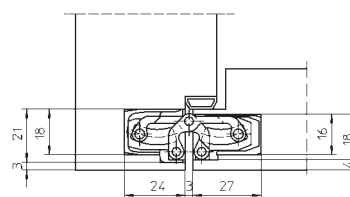
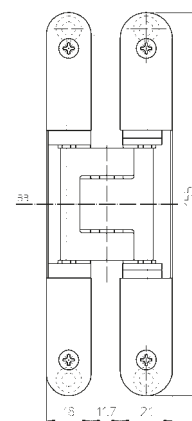

TECTUS®

TE 340 3D

for unrebated residential and heavy-duty doors

hinge	up to 80 kg
--------------	--------------------

Product features

- completely concealed hinge system
- for timber, steel or aluminium frames
- for unrebated residential and heavy-duty doors
- sideways closed hinge body for a homogeneous mortise appearance
- comfortable 3D adjustment (side +/- 3.0 mm, height +/- 3.0 mm, compression +/- 1.0 mm)
- maintenance-free slide bearings

Technical details

load capacity	i two hinges per door leaf (1x2m)	80.0 kg
overall length		160.0 mm
width (frame part)		28.0 mm
width (door part)		28.0 mm
cutter diameter		24.0 mm
opening angle		180°

Finishes

polished brass (030), polished nickelled (038), satin brass (047), RAL 9016 Traffic White (070), Grey Matte C37 (088), RAL 9005 Matte Black (107), Satin Chrome Look (F1) (124), Satin Nickel Look (F2) (125), Stainless Steel Look (SSL) (126), Satin Nickel (144), Satin Chrome (146), Rustic Umber (156), Bronze Metallic (168), Bronze Finish (174), Bronze Finish light (175), Bronze Finish dark (176) other finishes available upon request

Combination

receiver	casing frame	TE 340 3D FZ
	steel frame	TE 340 3D SZ
	steel door	TE 340 3D ST

Installation tools

jig		universal milling frame drilling jig TECTUS TE 340 3D
step 1	template	No. 5 250693 5
step 2	template	No. 5 250694 5

Functional areas

fire resistance, smoke resistance, burglar resistance

Note

i The load capacity mentioned above refers to the use of two hinges per door leaf (1x2 m).
With an opening position of 180° the door may have to be fixed additionally.

Classification key

3	7	4	1*1	1	-*2	0	11
----------	----------	----------	------------	----------	------------	----------	-----------

*1 Test evidence for functional doors to be achieved with full door sets and assemblies.

*2 depending on the finish

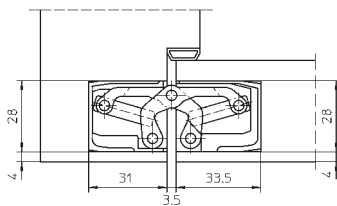
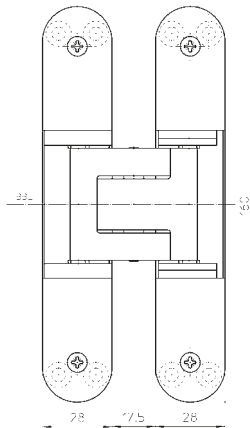

Quality marks



Functional areas



TECTUS®

TE 526 3D

made of solid stainless steel for unrebated heavy-duty doors

hinge **up to 120 kg**

Product features

- material stainless steel
- completely concealed hinge system
- for timber, steel or aluminium frames
- for unrebated heavy-duty doors
- 3D adjustment (side +/- 3.0 mm, height +/- 3.0 mm, compression +/- 1.0 mm)
- maintenance-free slide bearings

Technical details

load capacity	i two hinges per door leaf (1x2m)	120.0 kg
overall length		155.0 mm
width (frame part)		26.0 mm
width (door part)		26.0 mm
cutter diameter		24.0 mm
opening angle		180°

Finishes

Satin Stainless Steel (040), pol. Stainless Steel (042), coloured (079)

Combination

receiver	casing frame	TE 526/527 3D FZ
	steel frame	TE 526/527 3D SZ
	steel door	TE 526/527 3D ST

Installation tools

jig		universal milling frame drilling jig TECTUS TE 526 3D
frame / door	template	No. 5 250547 6

Functional areas

fire resistance, smoke resistance, soundproof, burglar resistance

Note

i The load capacity mentioned above refers to the use of two hinges per door leaf (1x2 m).

Test evidence for functional doors to be achieved with full door sets.

With an opening position of 180° the door may have to be fixed additionally.

Also available in Satin Stainless Steel grade 316.

Classification key

4	7	6	1*1	1	4	0	13
---	---	---	-----	---	---	---	----

*1 Test evidence for functional doors to be achieved with full door sets and assemblies.

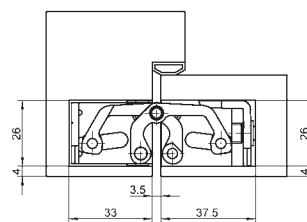
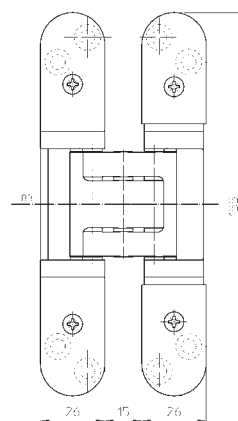

TECTUS®

TE 527 3D

made of solid steel for unrebated heavy-duty doors



hinge	up to 120 kg
--------------	---------------------

Product features

- material solid steel
- completely concealed hinge system
- for timber, steel or aluminium frames
- for unrebated heavy-duty doors
- 3D adjustment (side +/- 3.0 mm, height +/- 3.0 mm, compression +/- 1.0 mm)
- maintenance-free slide bearings

Technical details

load capacity	i two hinges per door leaf (1x2m)	120.0 kg
overall length		155.0 mm
width (frame part)		26.0 mm
width (door part)		26.0 mm
cutter diameter		24.0 mm
opening angle		180°

Finishes

Stainless Steel Look (SSL) (126), coloured (079), other finishes available upon request

Combination

receiver	casing frame	TE 526/527 3D FZ
	steel frame	TE 526/527 3D SZ
	steel door	TE 526/527 3D ST

Installation tools

jig	universal milling frame drilling jig TECTUS TE 527 3D
frame / door	template No. 5 250547 6

Functional areas

fire resistance, smoke resistance, soundproof, burglar resistance

Note

i The load capacity mentioned above refers to the use of two hinges per door leaf (1x2 m).

Test evidence for functional doors to be achieved with full door sets.

With an opening position of 180° the door may have to be fixed additionally.

Classification key

4	7	6	1*1	1	—*2	0	13
---	---	---	-----	---	-----	---	----

*1 Test evidence for functional doors to be achieved with full door sets and assemblies.

*2 depending on the finish

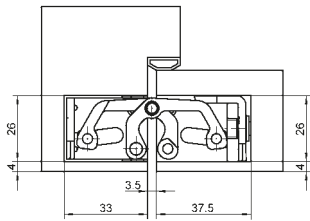
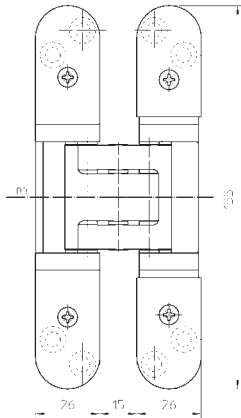

TECTUS®

TE 540 3D

for unrebated heavy-duty doors

hinge **up to 120 kg**

Product features

- completely concealed hinge system
- for timber, steel or aluminium frames
- for unrebated heavy-duty doors
- sideways closed hinge body for a homogeneous mortise appearance
- comfortable 3D adjustment (side +/- 3.0 mm, height +/- 3.0 mm, compression +/- 1.0 mm)
- maintenance-free slide bearings

Technical details

load capacity	i two hinges per door leaf (1x2m)	120.0 kg
overall length		200.0 mm
width (frame part)		32.0 mm
width (door part)		32.0 mm
cutter diameter		24.0 mm
opening angle		180°

Finishes

polished brassed (030), polished nickelled (038), satin brassed (047), RAL 9016 Traffic White (070), RAL 9005 Matte Black (107), Satin Chrome Look (F1) (124), Satin Nickel Look (F2) (125), Stainless Steel Look (SSL) (126), Satin Nickel (144), Satin Chrome (146), Rustic Umber (156), Bronze Metallic (168), Bronze Finish (174), Bronze Finish light (175), Bronze Finish dark (176), coloured (079), other finishes available upon request

Combination

receiver	casing frame	TE 540 3D FZ
	steel frame	TE 540 3D SZ
	steel door	TE 540 3D ST

Installation tools

jig		universal milling frame
step 1	template	No. 5 250680 5
step 2	template	No. 5 250681 5

Functional areas

fire resistance, smoke resistance, soundproof, burglar resistance

Note

i The load capacity mentioned above refers to the use of two hinges per door leaf (1x2 m).

Test evidence for functional doors to be achieved with full door sets.

With an opening position of 180° the door may have to be fixed additionally.

Classification key

4	7	6	1*1	1	—*2	1	13
----------	----------	----------	------------	----------	------------	----------	-----------

*1 Test evidence for functional doors to be achieved with full door sets and assemblies.

*2 depending on the finish

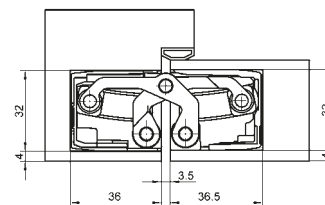
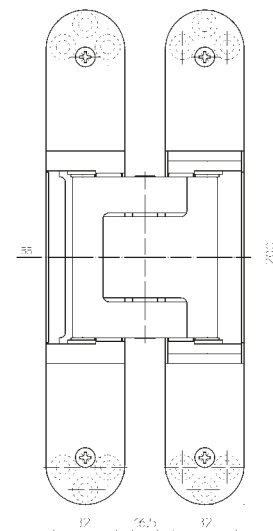

Quality marks



Functional areas



TECTUS®

TE 640 3D

for unrebated high performance heavy-duty doors



hinge **up to 200 kg**

Product features

- completely concealed hinge system
- for timber, steel or aluminium frames
- for unrebated high performance heavy-duty doors
- sideways closed hinge body for a homogeneous mortise appearance
- comfortable 3D adjustment (side +/- 3.0 mm, height +/- 3.0 mm, compression +/- 1.0 mm)
- maintenance-free slide bearings

Technical details

load capacity	i two hinges per door leaf (1x2m)	200.0 kg
overall length		240.0 mm
width (frame part)		32.0 mm
width (door part)		32.0 mm
cutter diameter		24.0 mm
opening angle		180°

Finishes

polished brass (030), polished nickelled (038), satin brass (047), RAL 9016 Traffic White (070), RAL 9005 Matte Black (107), Satin Chrome Look (F1) (124), Satin Nickel Look (F2) (125), Stainless Steel Look (SSL) (126), Satin Nickel (144), Satin Chrome (146), Rustic Umber (156), Bronze Metallic (168), Bronze Finish (174), Bronze Finish light (175), Bronze Finish dark (176), coloured (079), other finishes available upon request

Combination

receiver	block frame	TE 640 3D BW
	casing frame	TE 640 3D FZ
	steel frame	TE 640 3D SZ
	steel door	TE 640 3D ST

Installation tools

jig		universal milling frame
step 1	template	No. 5 250659 5
step 2	template	No. 5 250689 5

Functional areas

fire resistance, smoke resistance, soundproof, burglar resistance

Note

i The load capacity mentioned above refers to the use of two hinges per door leaf (1x2 m). Also the load capacities of the respective combined receiver have to be taken into consideration. With an opening position of 180° the door may have to be fixed additionally.

Classification key

4	7	6	1*1	1	—*2	1	14
---	---	---	-----	---	-----	---	----

*1 Test evidence for functional doors to be achieved with full door sets and assemblies.

*2 depending on the finish

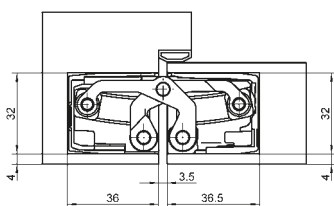
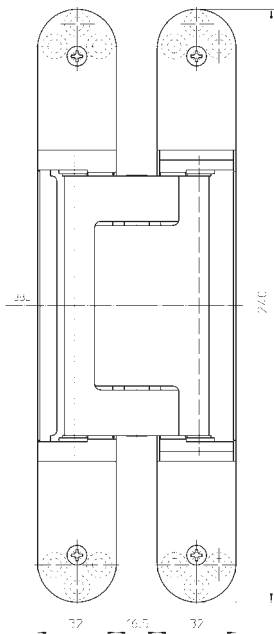

Quality marks



Functional areas



TECTUS®

TE 645 3D

for unrebated high performance heavy-duty doors

hinge **up to 300 kg**

Product features

- completely concealed hinge system
- for timber, steel or aluminium frames
- for unrebated high performance heavy-duty doors
- sideways closed hinge body for a homogeneous mortise appearance
- comfortable 3D adjustment (side +/- 3.0 mm, height +/- 3.0 mm, compression +/- 1.0 mm)
- maintenance-free slide bearings

Technical details

load capacity	i two hinges per door leaf (1x2m)	300.0 kg
width (frame part)		36.0 mm
width (door part)		34.0 mm
length (frame part)		280.0 mm
length (door part)		260.0 mm
cutter diameter		24.0 mm
opening angle		180°

Finishes

satin brassed (047), RAL 9005 Matte Black (107), Satin Chrome Look (F1) (124), Satin Nickel Look (F2) (125), Stainless Steel Look (SSL) (126), other finishes available upon request

Combination

receiver	steel frame	TE 645 3D SZ
	steel door	TE 645 3D ST

Installation tools

jig		universal milling frame lang
frame, step 1	template	No. 5 250945 5
frame, step 2	template	No. 5 250946 5
door, step 1	template	No. 5 250947 5
door, step 2	template	No. 5 250948 5

Functional areas

fire resistance, smoke resistance, soundproof, burglar resistance

Note

i The load capacity mentioned above refers to the use of two hinges per door leaf (1x2 m). Also the load capacities of the respective combined receiver have to be taken into consideration.

Test evidence for functional doors to be achieved with full door sets.

Application on steel frames is subject to special frame facings.

With an opening position of 180° the door may have to be fixed additionally.

Classification key

4	7	7	1*1	1	—*2	1	14
---	---	---	-----	---	-----	---	----

*1 Test evidence for functional doors to be achieved with full door sets and assemblies.

*2 depending on the finish

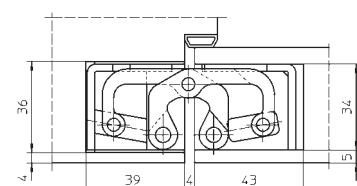
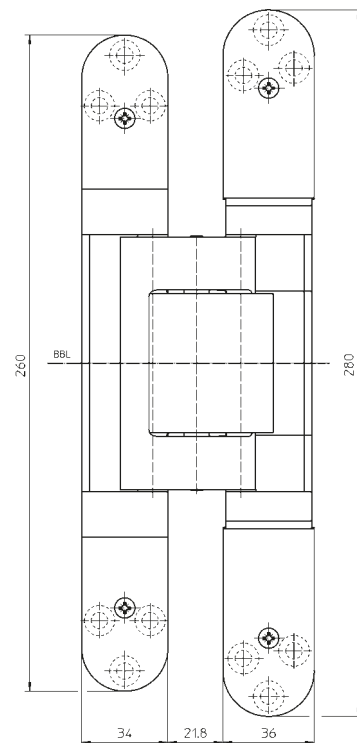



TECTUS®

Versions for special applications

Special architectural situations, problematic spatial challenges or unusual planning tasks require individual solutions. The solutions presented here by SIMONSWERK complete the TECTUS product range.



TECTUS® A8

for doors with claddings up to 8 mm
load capacities of 100 to 300 kg



TECTUS® Energy

with permanent energy transfer
load capacities of 60 to 300 kg

**TECTUS® FVZ**

for constructions with recessed
frame facings
load capacities of 60 to 100 kg

**TECTUS® rebated**

for rebated doors
load capacities up to 60 kg

**TECTUS® TE 680 3D FD**

for rebated timber entrance doors
load capacities up to 160 kg

**TECTUS® FR**

with integrated intumescent kit
load capacities of 80 to 200 kg

TECTUS® A8

Cladding on the door and frame construction

“A8” versions provide new application possibilities as they can accommodate claddings of up to 8 mm on the door and frame construction. This gives the designer more scope when integrating the door set into the overall interior design concept.

load capacity
up to 300 kg



**for claddings on door and frame
of up to 8 mm**

The use of different materials
such as wood, glass, etc are
possible within door and
frame construction

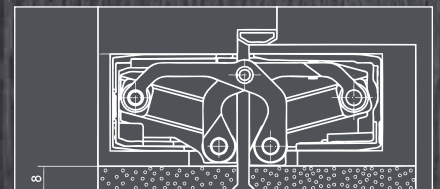

TECTUS®

TECTUS A8

for unrebated heavy-duty doors with claddings up to 8 mm

hinge	cladding	100 – 300 kg
--------------	-----------------	---------------------



eg. TE 540 3D A8

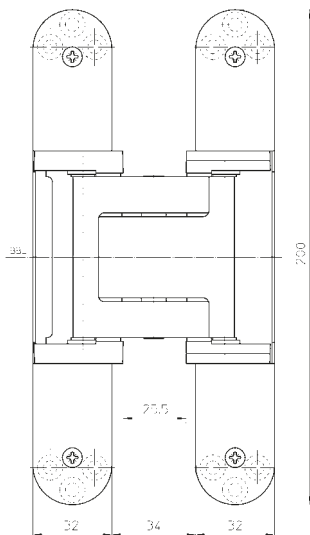

eg. TE 540 3D A8

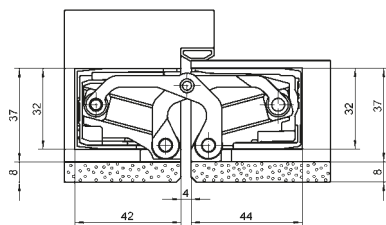

eg. TE 540 3D A8

Product features

- claddings up to 8 mm
- completely concealed hinge system
- for timber, steel or aluminium frames
- for unrebated heavy-duty doors
- sideways closed hinge body for a homogeneous mortise appearance
- comfortable 3D adjustment (side +/- 3.0 mm, height +/- 3.0 mm, compression +/- 1.0 mm)
- maintenance-free slide bearings

Finishes

Satin Stainless Steel (040) (TE 626 3D A8 only), Satin Chrome Look (F1) (124), Satin Nickel Look (F2) (125), Stainless Steel Look (SSL) (126), polished brass (030), polished nickelled (038), Bronze Finish (174), Bronze Finish Light (175), Bronze Finish Dark (176), coloured (079), other finishes available upon request

Combination

receiver	block frame	TE 626/640 3D A8 BW/1
	casing frame	TE ... 3D FZ
	steel frame	TE ... 3D A8 SZ
	steel door	TE ... 3D A8 ST
accessories	cover plate set	TE 540/640 3D A8 radius

Functional areas

fire resistance, smoke resistance, soundproof, burglar resistance

Note

i The load capacity mentioned above refers to the use of two hinges per door leaf (1x2 m). Also the load capacities of the respective combined receiver have to be taken into consideration.

Application on steel frames is subject to special frame facings.

With an opening position of 180° the door may have to be fixed additionally.

Classification key

Detailed information in our PRODUCTSELECTOR at www.simonswerk.com

Available options

load capacity up to 100 kg	TE 540 3D A8
	TE 540 3D A8 Energy
load capacity up to 160 kg	TE 640 3D A8
	TE 640 3D A8 Energy
load capacity up to 300 kg	TE 626 3D A8
	TE 626 3D A8 Energy

Detailed information in our PRODUCTSELECTOR at www.simonswerk.com

Quality marks



Functional areas



TECTUS® Energy Integrated and permanent energy transfer

Energy transfer is crucially important in the installation and operation of electric components in high-quality doors. With TECTUS Energy, the door leaf receives a guaranteed and permanent energy supply from the frame, without weakening the structure of either the door or the frame. The technology provided by TECTUS Energy offers compatibility with all the most popular designs for locks and fittings.



Clip

- secure connection between cable and hinge housing
- high functional reliability and fitness for purpose thanks to a closed system

Adapter technology

- compatibility with all the most popular designs for locks and fittings
- three different plug connections (round cable, universal adapter, adapter 1)

Flat ribbon cable

- 16-wire ribbon cable
- integrated permanent energy transfer
- entirely enclosed in the housing (closed system)

TECTUS®

TECTUS Energy

with permanent energy transfer for unrebated heavy-duty doors

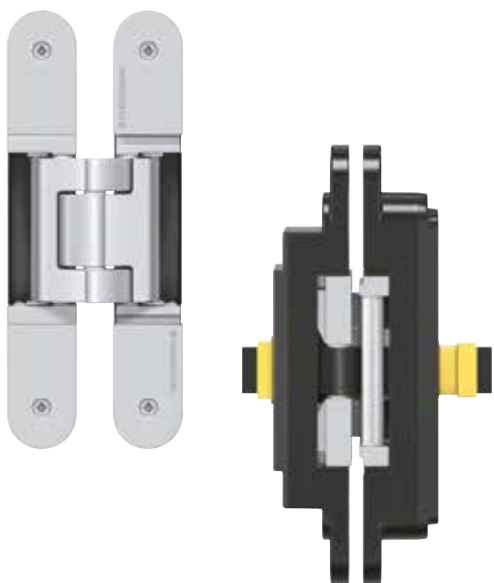

eg. TE 540 3D Energy

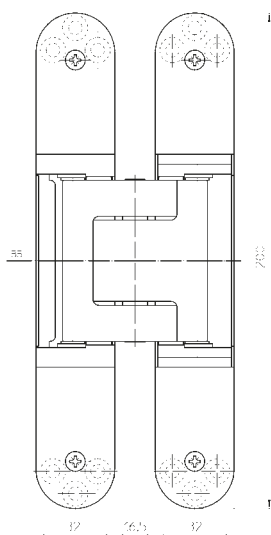

eg. TE 540 3D Energy

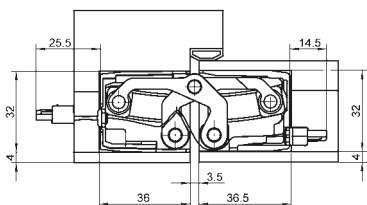

eg. TE 540 3D Energy

hinge	energy transfer	60 – 300 kg
--------------	------------------------	--------------------

Product features

- with permanent energy transfer
- individual connection adapter options
- completely concealed hinge system
- for timber, steel or aluminium frames
- for unrebated heavy-duty doors
- comfortable 3D adjustment (side +/- 3.0 mm, height +/- 3.0 mm, compression +/- 1.0 mm)
- maintenance-free slide bearings

Technical details

no. of wires/wire cross section	16 pieces/0,14 mm ²
max. voltage	50 V (voltage source acc. SELV-DIN EN 61140)
max. current	0,8 A (per wire)
opening angle	180°

Finishes

Stainless Steel (040), RAL 9005 Matte Black (107), Satin Chrome Look (F1) (124), Satin Nickel Look (F2) (125), Stainless Steel Look (SSL) (126), other finishes available upon request

Combination

receiver	casing frame	TE ... 3D FZ
	steel frame	TE ... 3D SZ
	steel door	TE ... 3D ST
accessories	i adapter TECTUS Energy	

Functional areas

fire resistance, smoke resistance, soundproof, burglar resistance

Note

i When ordering the accessories please consider: There are two connection adapters TECTUS Energy needed per hinge. A connection plan can be downloaded in our PRODUCTSELECTOR at www.simonswerk.com.

i The load capacity mentioned above refers to the use of two hinges per door leaf (1x2 m).

With an opening position of 180° the door may have to be fixed additionally.

Classification key

Detailed information in our PRODUCTSELECTOR at www.simonswerk.com

Available options

load capacity up to 60 kg	TE 240 3D Energy
load capacity up to 80 kg	TE 340 3D Energy
load capacity up to 100 kg	TE 540 3D A8 Energy
load capacity up to 120 kg	TE 526 3D Energy
	TE 540 3D Energy
load capacity up to 160 kg	TE 640 3D A8 Energy
load capacity up to 200 kg	TE 640 3D Energy
load capacity up to 300 kg	TE 645 3D Energy
	TE 626 3D A8 Energy

Detailed information in our PRODUCTSELECTOR at www.simonswerk.com

Quality marks



Functional areas



TECTUS® FVZ

Integration of door set into surrounding wall without a visible frame

The model versions TECTUS FVZ where the frame part is offset to the leaf part enables a door with a completely concealed hinge to be integrated into the surrounding wall without any visible frame. The frame facing can be set back by 12 or 14 mm, to allow the door and wall sets to create a flush-fitting whole.

load capacity
up to 100 kg



**for 12 or 14 mm
recessed frame facings**

for a surrounding wall
without a visible frame

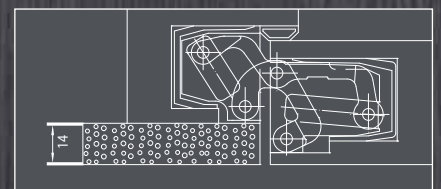

TECTUS®

TECTUS FVZ

for unrebated residential and heavy-duty doors with recessed frame facings

hinge	recessed frame facings	60 – 100 kg
-------	------------------------	-------------



eg. TE 541 3D FVZ

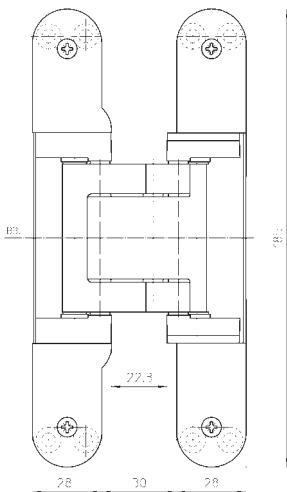

eg. TE 541 3D FVZ

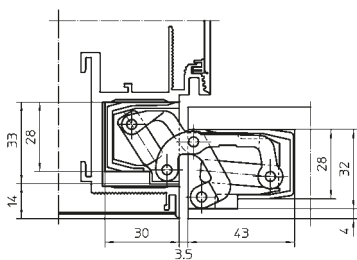

eg. TE 311 3D FVZ 40

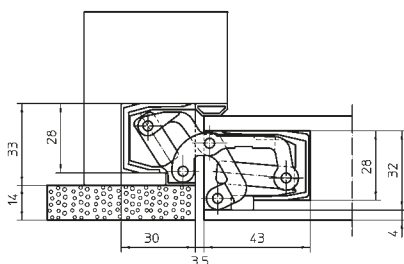

eg. TE 541 3D FVZ

Product features

- FVZ = recessed frame facings
- recessed frame facing 12.0 or 14.0 mm
- completely concealed hinge system
- for timber, steel or aluminium frames
- for unrebated heavy-duty doors
- sideways closed hinge body for a homogeneous mortise appearance
- comfortable 3D adjustment (side +/- 3.0 mm, height +/- 3.0 mm, compression +/- 1.0 mm)
- maintenance-free slide bearings

Finishes

polished brass (O30), polished nickelled (O38), satin brass (O47), RAL 9016 Traffic White (O70), RAL 9005 Matte Black (107), Satin Chrome Look (F1) (124), Satin Nickel Look (F2) (125), Stainless Steel Look (SSL) (126), Satin Nickel (144), Satin Chrome (146), Rustic Umber (156), Bronze Metallic (168), Bronze Finish (174), Bronze Finish light (175), Bronze Finish dark (176), other finishes available upon request

Combination

receiver	casing frame	TE... 3D FVZ FZ
	steel frame	TE... 3D FVZ SZ
	steel door	TE... 3D FVZ ST

Functional areas

fire resistance, smoke resistance, soundproof

Note

i The load capacity mentioned above refers to the use of two hinges per door leaf (1x2 m).

Test evidence for functional doors to be achieved with full door sets.

Classification key

Detailed information in our PRODUCTSELECTOR at www.simonswerk.com

Available options

load capacity up to 60 kg	door thickness 40 mm	TE 311 3D FVZ 40
	door thickness 44 mm	TE 311 3D FVZ 44
load capacity up to 100 kg		TE 541 3D FVZ

Detailed information in our PRODUCTSELECTOR at www.simonswerk.com

Quality marks



Functional areas



TECTUS® rebated for rebated residential doors

SIMONSWERK also offers within the TECTUS brand a solution for rebated door leaf. The concealed hinge system is completely invisible when the door is closed. The hinge joint's special geometry allows for installation in the rebated door leaf with a receiver in the wood, steel or aluminium frame.



load capacity
up to 60 kg

for rebated residential doors

TECTUS®

TE 380 3D

for rebated residential doors

hinge	rebated	up to 60 kg
--------------	----------------	--------------------

Product features

- completely concealed hinge system
- for timber, steel or aluminium frames
- for rebated residential doors
- sideways closed hinge body for a homogeneous mortise appearance
- comfortable 3D adjustment (side +/- 3.0 mm, height +/- 3.0 mm, compression +/- 1.0 mm)
- maintenance-free slide bearings

Technical details

load capacity	i two hinges per door leaf (1x2m)	60.0 kg
width (frame part)		26.0 mm
width (door part)		20.0 mm
length (frame part)		190.0 mm
length (door part)		160.0 mm
cutter diameter		20.0 mm
opening angle		180°

Finishes

RAL 9016 Matte Traffic White (057), RAL 9005 Matte Black (107), Satin Chrome Look (F1) (124), Satin Nickel Look (F2) (125), Stainless Steel Look (SSL) (126), other finishes available upon request

Combination

receiver	casing frame	TE 380 3D FZ
	steel frame	TE 380 3D SZ

Installation tools

jig		universal milling frame
frame, step 1	template	No. 5 250955 5
frame, step 2	template	No. 5 250956 5
frame, step 3	template	No. 5 250957 5
door, step 1	template	No. 5 250958 5
door, step 2	template	No. 5 250959 5

Detailed information in our PRODUCTSELECTOR at www.simonswerk.com

Note

i The load capacity mentioned above refers to the use of two hinges per door leaf (1x2 m).

With an opening position of 180° the door may have to be fixed additionally.

Classification key

2	7	3	1*1	1	—*2	0	10
----------	----------	----------	------------	----------	------------	----------	-----------

*1 Test evidence for functional doors to be achieved with full door sets and assemblies.

*2 depending on the finish

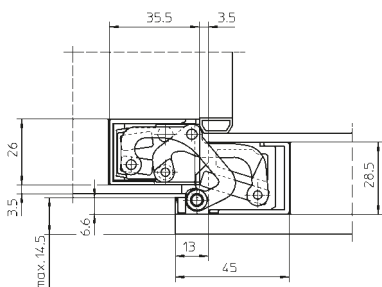
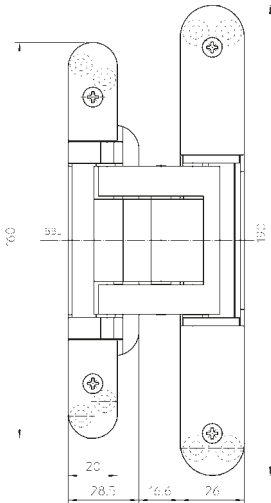

TECTUS® TE 680 3D FD for rebated entrance doors

With the new model version TECTUS TE 680 3D FD, SIMONSWERK offers a solution for conventional, rebated timber entrance doors. Easy mounting and comfortable 3D adjustment make installation easy, while a circumferential seal ensures the required level of impermeability around the hinges.

180 degrees
opening angle

load capacity
up to 160 kg

continuous
sealing system

comfortable
3D adjustment



TECTUS®

TE 680 3D FD

for rebated entrance doors

hinge	rebated	up to 160 kg
--------------	----------------	---------------------

Product features

- concealed hinge system
- for rebated entrance doors
- sideways closed hinge body for a homogeneous mortise appearance
- comfortable 3D adjustment (side +/- 3.0 mm, height +/- 3.0 mm, compression +/- 1.5 mm)
- continuous sealing system
- 18 mm overlap width
- maintenance-free slide bearings

Technical details

load capacity	i two hinges per door leaf (1x2m)	160.0 kg
width (frame part)		30.0 mm
width (door part)		40,5 mm
length (frame part)		250.0 mm
length (door part)		140.0 mm
cutter diameter		20.0 mm
opening angle		180°

Finishes

RAL 9005 Matte Black (107), Satin Chrome Look (F1) (124), other finishes available upon request

Combination

hinge	TE 680 3D FD Energy	
receiver	slim blind frame	TE 680 3D BZ
accessories	gasket	DS 7435

Installation tools

jig	routing jig TE 680 3D FD serial routing jig TE 680 3D FD	
door	overlap 21, 22 mm	template Nr. 5 251109 5
	overlap 23 mm	template Nr. 5 251110 5
	overlap 24 – 27 mm	template Nr. 5 251111 5
frame	overlap 21 mm	template Nr. 5 251112 5
	overlap 22, 23 mm	template Nr. 5 251113 5
	overlap 24, 25 mm	template Nr. 5 251114 5
	overlap 26 mm	template Nr. 5 251115 5
	overlap 27 mm	template Nr. 5 251116 5

Functional areas

burglar resistance

Note

i The load capacity mentioned above refers to the use of two hinges per door leaf (1x2 m).

With an opening position of 180° the door may have to be fixed additionally.

Classification key

4	7	7	0	1	—*1	1	14
----------	----------	----------	----------	----------	------------	----------	-----------

*1 depending on the finish

Available options

TE 680 3D FD Energy

Detailed information in our PRODUCTSELECTOR at www.simonswerk.com

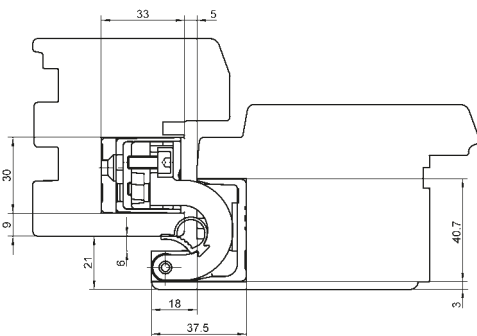
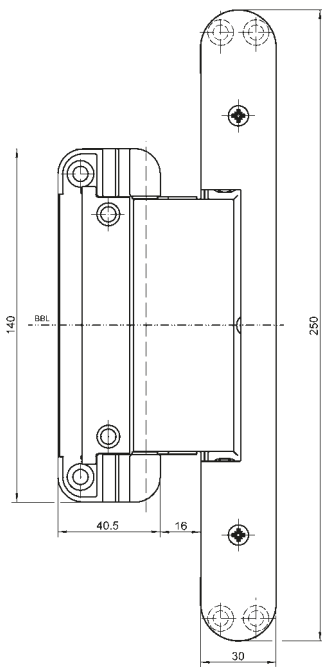

eg. overlap width 21 mm



TECTUS® FR with integrated intumescent kit

The TECTUS hinge system with integrated intumescent kit protects against fire and smoke escaping into a neighbouring room. In case of a fire, the intumescent kit swells, sealing the door around the hinges.

load capacity
up to 200 kg



with integrated intumescent kit

The intumescent kit seals the hinge mortise in case of a fire.

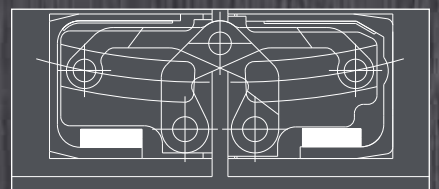

TECTUS®

TECTUS FR

with integrated intumescent kit for unrebated heavy-duty doors



eg. TE 540 3D FR

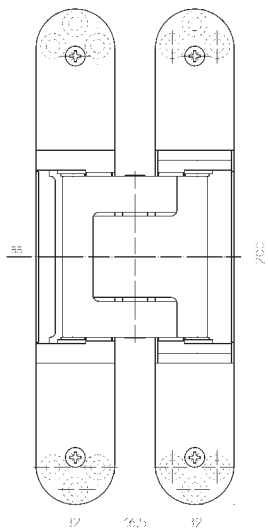

eg. TE 540 3D FR

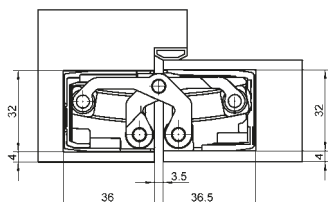

eg. TE 540 3D FR

hinge	fire resistance	80 – 200 kg
--------------	------------------------	--------------------

Product features

- with integrated intumescent kit
- completely concealed hinge system
- for timber, steel or aluminium frames
- for unrebated heavy-duty doors
- sideways closed hinge body for a homogeneous mortise appearance
- comfortable 3D adjustment (side +/- 3.0 mm, height +/- 3.0 mm, compression +/- 1.0 mm)
- maintenance-free slide bearings

Finishes

Satin Chrome Look (F1) (124), Stainless Steel Look (SSL) (126), other finishes available upon request

Combination

receiver	casing frame	TE ... 3D FZ
	steel frame	TE ... 3D SZ
	steel door	TE ... 3D ST

Functional areas

fire resistance, smoke resistance, soundproof, burglar resistance

Note

i The load capacity mentioned above refers to the use of two hinges per door leaf (1x2 m).

Test evidence for functional doors to be achieved with full door sets.

Classification key

Detailed information in our PRODUCTSELECTOR at www.simonswerk.com

Available options

load capacity up to 80 kg	TE 340 3D FR
load capacity up to 100 kg	TE 540 3D A8 FR
	TE 541 3D FVZ FR
load capacity up to 120 kg	TE 540 3D FR
load capacity up to 200 kg	TE 640 3D FR
load capacity up to 160 kg	TE 640 3D A8 FR

Detailed information in our PRODUCTSELECTOR at www.simonswerk.com

Quality marks



Functional areas



TECTUS®

TE 640 3D BW

fixing angle for unrebeated heavy-duty doors with claddings up to 16 resp. 20 mm on both sides

receiver		block frame
-----------------	--	--------------------

Technical details

load capacity	i two hinges per door leaf (1x2m)	120.0 kg
---------------	--	----------

Finishes

blue galvanized (010)

Combination

hinge	TE 640 3D
-------	-----------

Note

i The load capacity mentioned above refers to the use of two hinges per door leaf (1x2 m).

The cladding must be mortised in the hinge area.

Please specify the exact version in your order.

Available options

claddings up to 16 mm	TE 640 3D BW 16
claddings up to 20 mm	TE 640 3D BW 20

Detailed information in our PRODUCTSELECTOR at www.simonswerk.com

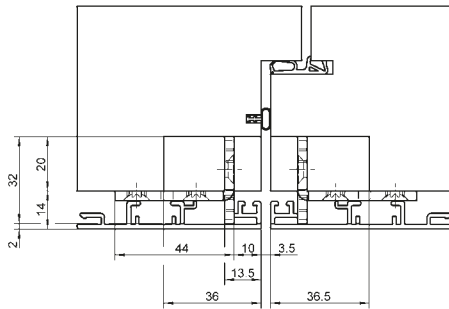

timber/aluminium system

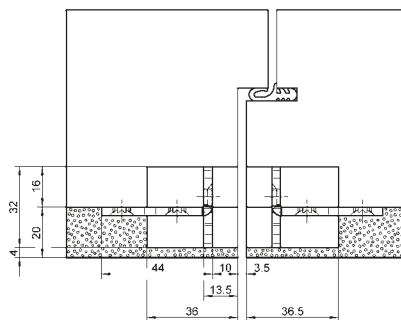
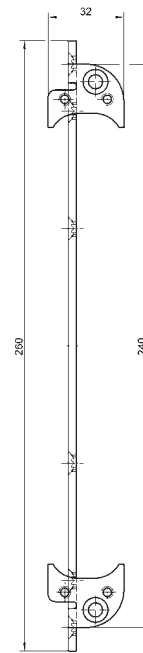

claddings up to 20 mm

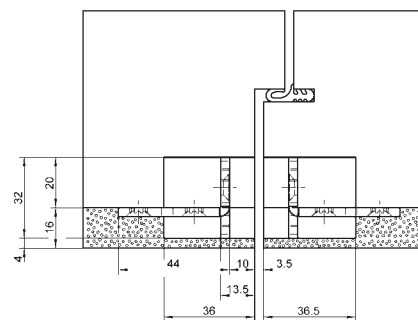

claddings up to 16 mm

TECTUS®

TE 626/640 3D A8 BW/1

fixing angle for unrebated heavy-duty doors with claddings up to 20mm on both sides



receiver		block frame
-----------------	--	--------------------

Technical details

load capacity	160.0 kg (in combination with TE 626 3D A8)
load capacity	120.0 kg (in combination with TE 640 3D A8)

Finishes

Satin Stainless Steel (040), Satin Chrome Look (F1) (124)

Combination

hinge	TE 640 3D A8
	TE 626 3D A8
	TE 640 3D A8 Energy
	TE 626 3D A8 Energy
	TE 640 3D A8 FR

Note

i The load capacity mentioned above refers to the use of two hinges per door leaf (1x2 m).

The cladding must be mortised in the hinge area.



e.g. TE 540 3D FZ/1

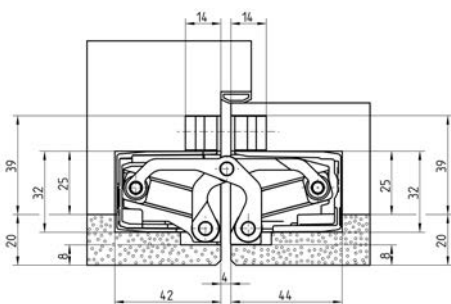

e.g. TE 540 3D with TE 540 3D FZ/1

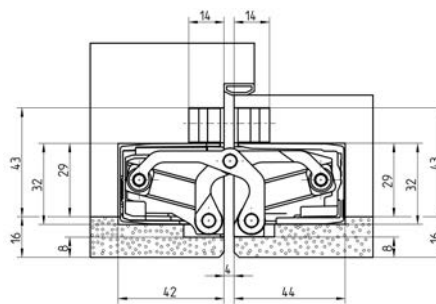

TECTUS®

Fixing plate TE ... 3D FZ

for residential and heavy-duty doors with casing frames

receiver	casing frame
----------	--------------

Finishes

blue galvanized (010)

Combination

hinge	TE 240 3D
	TE 311 3D FVZ
	TE 340 3D
	TE 380 3D
	TE 526 3D
	TE 527 3D
	TE 540 3D
	TE 541 3D FVZ
	TE 640 3D
	TE 540 3D A8
	TE 626 3D A8
	TE 640 3D A8
with energy transfer	TE 240 3D Energy
	TE 340 3D Energy
	TE 526 3D Energy
	TE 540 3D Energy
	TE 640 3D Energy
	TE 540 3D A8 Energy
	TE 640 3D A8 Energy
with intumescent kit	TE 540 3D FR
	TE 340 3D FR
	TE 540 3D FR
	TE 541 3D FVZ FR
	TE 640 3D FR
	TE 540 3D A8 FR
	TE 640 3D A8 FR

Note

Spacers for casing thicknesses of 22-28 mm are included.
Please specify the exact hinge in your order.

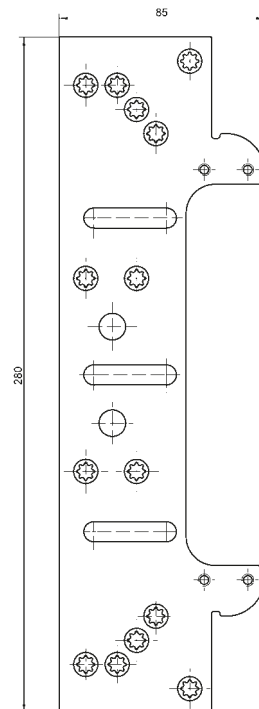
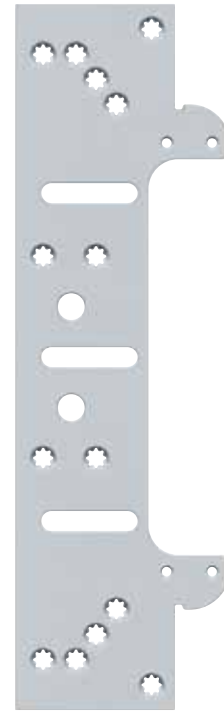

eg. TE 540 3D FZ/1

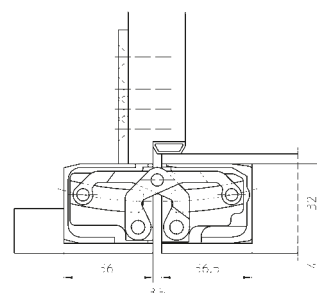

eg. TE 540 3D with TE 540 3D FZ/1

TECTUS®

Receiver TE ... 3D SZ

for residential and heavy-duty doors with steel frames

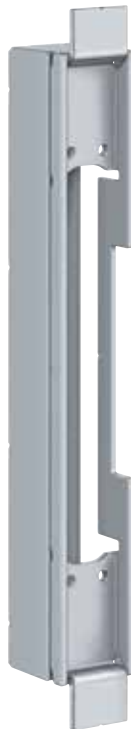

receiver	steel frame
----------	-------------

Finishes

blue galvanized (010), Stainless Steel untreated (041)

Combination

hinge	TE 240 3D
	TE 311 3D FVZ
	TE 340 3D
	TE 380 3D
	TE 526 3D
	TE 527 3D
	TE 540 3D
	TE 541 3D FVZ
	TE 640 3D
	TE 645 3D
	TE 540 3D A8
	TE 626 3D A8
	TE 640 3D A8
	with energy transfer
	TE 340 3D Energy
	TE 526 3D Energy
	TE 540 3D Energy
	TE 640 3D Energy
	TE 645 3D Energy
	TE 540 3D A8 Energy
	TE 626 3D A8 Energy
	TE 640 3D A8 Energy
with intumescent kit	TE 340 3D FR
	TE 540 3D FR
	TE 541 3D FVZ FR
	TE 640 3D FR
	TE 540 3D A8 FR
	TE 640 3D A8 FR

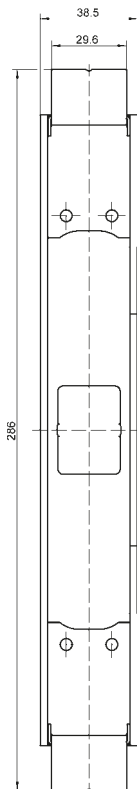

eg. TE 540 3D SZ

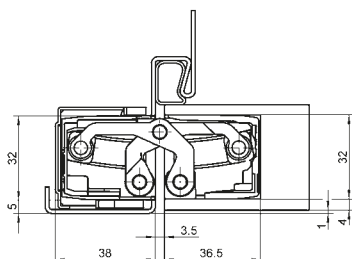

eg. TE 540 3D with TE 540 3D SZ/1

Note

Please specify the exact hinge in your order.

TECTUS®

Receiver TE ... 3D ST

for steel doors

receiver steel door

Finishes

blue galvanized (010)

Combination

hinge	TE 240 3D
	TE 340 3D
	TE 526 3D
	TE 527 3D
	TE 540 3D
	TE 541 3D FVZ
	TE 640 3D
	TE 645 3D
	TE 540 3D A8
	TE 640 3D A8
with energy transfer	TE 240 3D Energy
	TE 340 3D Energy
	TE 526 3D Energy
	TE 540 3D Energy
	TE 640 3D Energy
	TE 540 3D A8 Energy
	TE 640 3D A8 Energy
with intumescent kit	
TE 340 3D FR	
	TE 540 3D FR
	TE 541 3D FVZ FR
	TE 640 3D FR
	TE 540 3D A8 FR
	TE 640 3D A8 FR

Note

Please specify the exact hinge in your order.

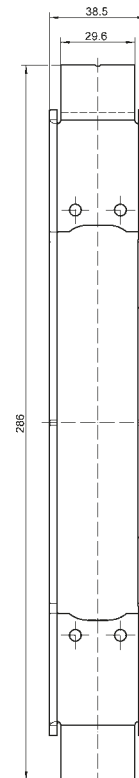
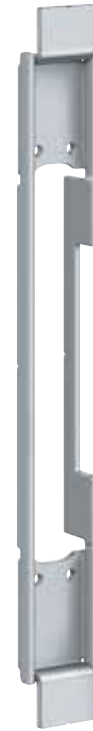

eg. TE 540 3D ST

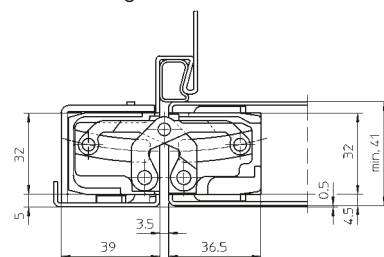

eg. TE 540 3D with TE 540 3D ST

Assembly

TECTUS series

door

Fix door part with enclosed wood screws.

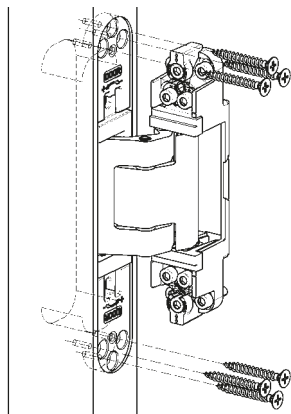

eg. TE 540 3D

frame

Block frame

Conduct routing, cutter 24 mm Ø (TE 240 3D cutter 16 mm Ø) and collar ring 30 mm Ø, affix frame part with enclosed wood screws.

Casing frame

To guarantee a stable mounting the use of an additional fixing plate is required. Affix the fixing plate behind the casing. Affix the hinge by using enclosed M5 screws.

Steel frame

Affix frame part of the hinge with the prepared receiver inside the door frame by using the enclosed M5 screws.

Fix cover plates on the frame and door part by means of the enclosed screws.

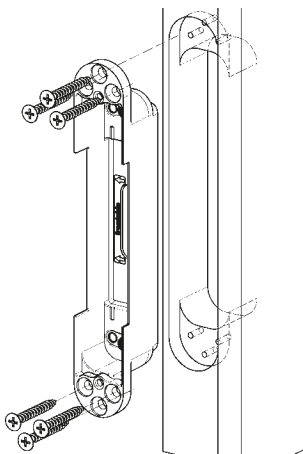

eg. TE 540 3D

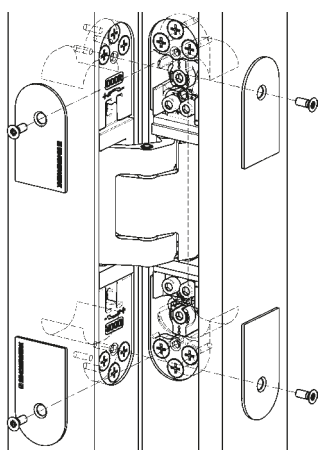

eg. TE 540 3D

Adjustment

TECTUS series

Three-dimensionally, continuously adjustable

side	+/- 3.0 mm
height	+/- 3.0 mm
compression	+/- 1.0 mm

Side adjustment

- adjust the adjusting spindles using an Allen wrench

Height adjustment

- slightly loosen the clamping screws
- adjust the vertical position of the door by turning the lower height adjustment screw
(turn the upper height adjustment screw in the opposite direction if necessary)
- retighten the clamping screws

Compression adjustment

- slightly loosen the fixing screws
- put the door to the correct compression by using the compression screw
- retighten the clamping screws

All adjustments to be conducted by means of a 4 mm Allen wrench.

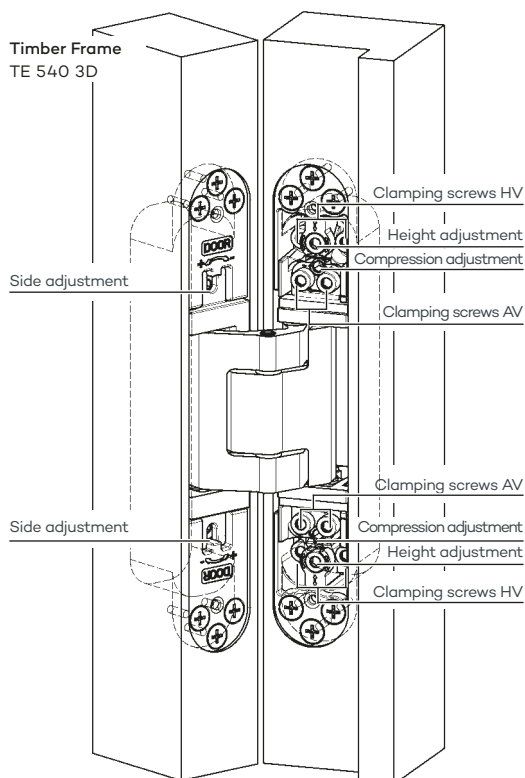

Hinge Positions

TECTUS Series

The use of a third hinge can significantly influence the load capacity. Frequently, a third hinge is positioned centred between the two outer hinges in order to meet visual requirements and to ensure the sealing pressure in the middle of the door. Under certain circumstances, however, it may be useful or necessary to support the upper hinge where the main tensile forces occur. This could be the case for over-wide doors (> 1000 mm) where additional forces occur due to the leverage. In such cases, the third hinge has to be positioned in the upper third, as this is the only way to positively influence the load capacity. The door norm recommends the use of a third hinge 350 mm below the upper hinge.

Application with increased load capacity or overhead door closers

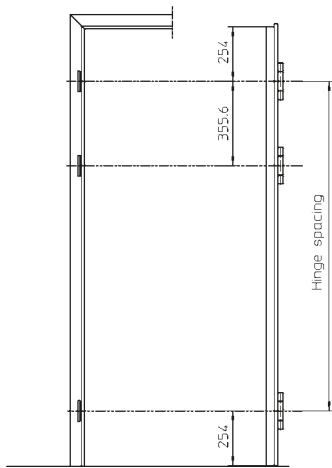

Examples for applications with different door heights

< 2.40 m

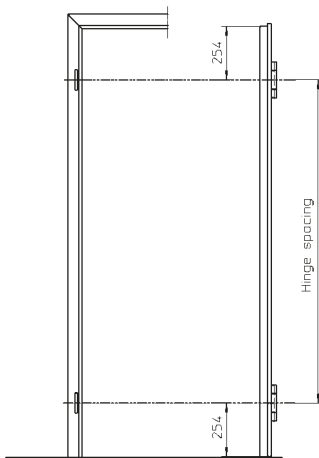

≥ 2.40 m

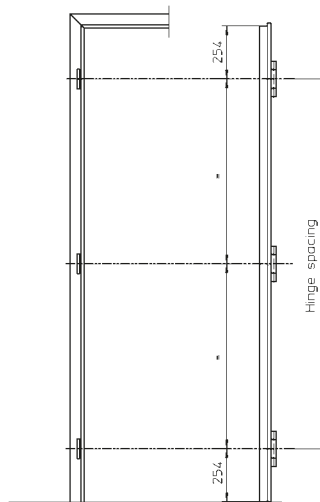

Note: We recommend for all exterior doors the use of three hinges.

Finishes

The colours of the finishes shown may differ from the original.
 Delivery time/product version must be clarified individually.
 Other finishes available upon request.



polished brassed (030)



polished nickelled (038)



Satin Stainless Steel (040)



satin brassed (047)



RAL 9016 Traffic White (070)



RAL 9005 Matte Deep Black (107)



Satin Chrome Look (124)



Satin Nickel Look (125)



Stainless Steel Look (126)



Satin Nickel (144)



Satin Chrome (146)



Rustic Umber (156)



Bronze Metallic (168)



Bronze Finish (174)



Bronze Finish Light (175)



Bronze Finish Dark (176)

Service – comprehensive expertise for your daily work

We are happy to provide you with all the documentation you need to choose the most suitable hinge system for your requirements. Please contact us: we would be delighted to work with you to choose the best solution – from high-quality standard sets right up to the most complex solutions.

All our brochures and data sheets can be requested in a printed version, or you can simply download them on the spot – and the same applies to our fitting instructions, declarations of performance and CAD data.

Visit our **PRODUCTSELECTOR**

Whether you are a manufacturer, trade partner or designer, at www.simonswerk.com you can find precise, detailed product descriptions that will help you to choose the most suitable hinge systems.

www.simonswerk.com



SIMONSWERK GROUP – excellence in product and service

As an internationally operating group of companies, the SIMONSWERK GROUP is the market leader in the area of high-quality hinge systems. With over 900 employees worldwide, we stand for the highest quality standards, constant willingness to innovate and long-lasting customer relationships.

The SIMONSWERK brand combines the entire expertise in hinge systems and unites technical know-how with design standards at the highest level. In addition to innovative product solutions, we offer our customers the best service exactly where it is needed. From personal customer consultations and competent training courses to customised delivery and logistics processes or digital service tools.

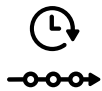

Over 130 years of experience

The perfect foundation for continuous growth with experience



Internationally successful

As the market leader, we are constantly expanding our know-how



Over 900 employees worldwide

Every single employee shapes the vision of the SIMONSWERK GROUP



Focused product solutions

With high-quality hinge systems for heavy-duty, residential and entrance doors, we offer product solutions for all applications and materials

For our customers and partners

As SIMONSWERK GROUP, we are active in a variety of business models. Both in the construction project business and in cooperation with door manufacturers as well as with hardware dealers and processors, we develop perfect solutions, depending on individual market needs. We will provide our customers and decision-makers with the best possible support as a partner in accordance with their various requirements.



SIMONSWERK

TECTUS®

The completely concealed hinge system

SIMONSWERK GmbH

Bosfelder Weg 5
33378 Rheda-Wiedenbrück
Germany

+49 5242 4130

info@simonswerk.de

www.simonswerk.de

Member of the

**SIMONSWERK
GROUP**

© SIMONSWERK GmbH
08/2023, 5 800313 0 00001/2.0
Subject to technical modifications.

